



Installation guide



Video tutorial



ENELION LUMINA

3 in 1 modular structure – build and upgrade your dreamed solution using the same base module. Quick installation – get your EV charger ready to work online in no more than 15 minutes of the installation process.

Dear Partner,

Congratulations on your purchase of the Enelion charger
and thank you for your trust.

Up-to-date manuals for users
and installers always available at:
<https://enelion.com/support-lumina/>

Please read this manual before installation
or prior to the station being commissioned.

Table of content

Introduction	6
Additional tools necessary for installation	6
Optional safety screws	7
Features	8
Technical specifications	9
Safety instructions	11
Before the installation	13
How to prepare the device for installation	14
ENELION LUMINA SOCKET	14
ENELION LUMINA ALU SOCKET	15
ENELION LUMINA ALU CABLE	16
Installation	17
Diagrams of connection variants	17
Overview diagrams of modules	18
Preparation	18
Power Supply Network Systems	18
Installation of mounting plate	21
Electrical connection	21
Alternative method for the insertion of power cables	23
M20 gland adapter	24

Table of content

Measuring a 230 V socket.	25
Ethernet connection.	27
Wired communication in ENELION LUMINA.	27
Step by step	29
Start-up and configuration of the station	33
Additional information for the UK market	34
Pen Fault Detection	34
Daily use and operation	35
How do I charge?	35
Interface LED	36
Maintenance	36
Cleaning	36
Practical details	37
Customer service	39

ENELION LUMINA products family



ENELION
LUMINA
ALU
CABLE



ENELION
LUMINA
ALU
SOCKET



ENELION
LUMINA
BACKPLATE



CLOSED

ENELION
LUMINA
SOCKET



OPENED

Additional tools necessary for installation

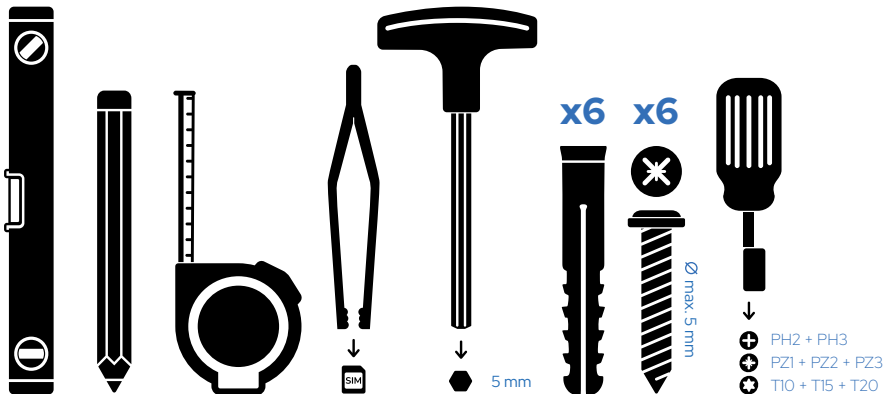

Optional safety screws

Each charger kit includes safety screws (additionally secured with a pin to prevent unauthorized access) that can replace the standard screws attaching the top part of the head to the back, if needed.

The appropriate bit is optionally available as an accessory or can be purchased separately (size T10H x 25 mm).



If you need the appropriate bit, you can order it from us under the index AKC-BIT-010.



Features

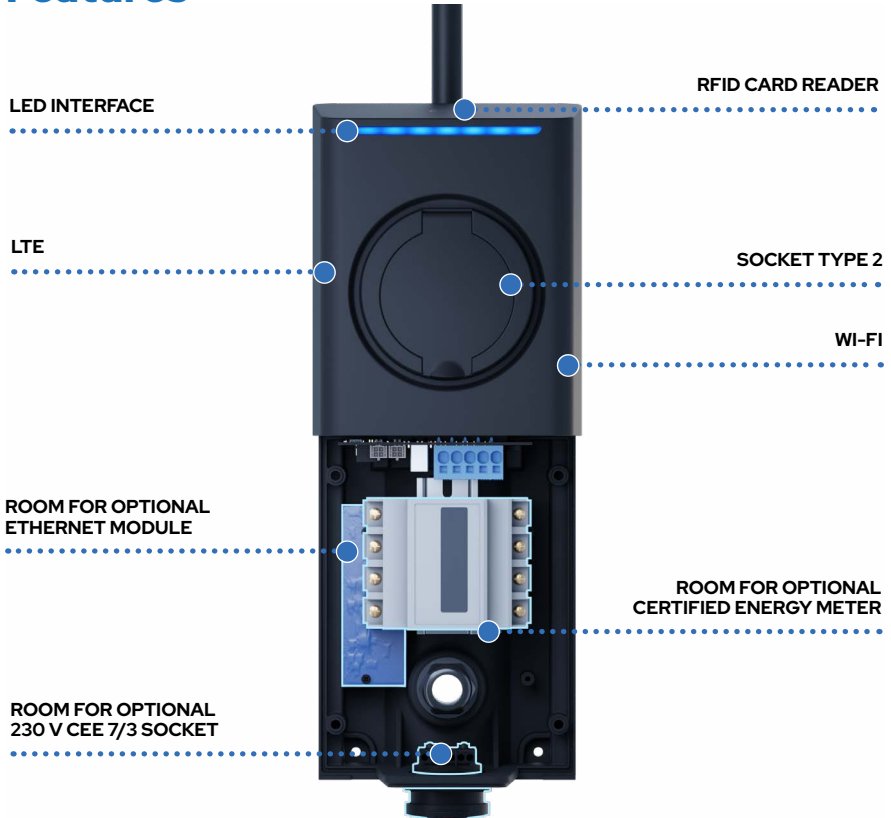

Technical specifications

Housing	Polycarbonate, anodised aluminium, powder coating*
Ingress protection rate	IP54
Impact protection	IK10
Flammability class	UL94-V0
Charging connector type	Enelion LUMINA SOCKET – Type 2 socket, Enelion LUMINA ALU CABLE – Type 2 connector with 5.2 m cord
Residual current protection	Embedded residual current monitor – Enelion RCMB 6 mA DC
Energy metering	Integrated 3-phase energy meter > 99% accuracy
Certified electricity meter (MID)	Impulse* – possible to install inside the housing
User interface	<ul style="list-style-type: none">• Multi-colour LED strip EVC status indication;• Dedicated app
Online communication unit	<ul style="list-style-type: none">• Integrated LTE/4G modem• Wi-Fi 2.4 GHz b/g/n – direct access point to the station with an option to hide the AP and connect the station to local Wi-Fi network
OCPP communication protocol	compliance with OCPP 1.6 J protocol
Minimal signal quality requirements	<ul style="list-style-type: none">• Wi-Fi: -60 dBm• GSM: -85 dBm
Authorization	<ul style="list-style-type: none">• Built-in RFID/NFC reader – Mifare Classic/Free mode• Dedicated app
Current/Charging power	<ul style="list-style-type: none">• Up to 7.4 kW at 32 A 1-phase• Up to 22 kW at 32 A 3-phase (TN system)
Charging voltage	3 × 400 V AC/230 V AC (±10%)

Supply voltage	3 x 400 V AC/230 V AC ($\pm 10\%$) (TN/IT) Possibility of connecting the cable from the top, bottom and the back of the station
Other features	<ul style="list-style-type: none"> • Configuration with no additional tools • Remotely controlled 230V socket (max. 2000W/10A)* • Temperature and humidity monitoring inside device • Remote start/stop, delayed start and end of charging
Operating temperature	From -30°C to +55°C
Maximum altitude for installation	2000 m
Height	390 mm
Depth	133 mm
Width	155 mm
Weight	3.3-8.9 kg (depending on device version)
Compliance	<p>2014/53/EU (RED); 2011/65/EU (RoHS), 2014/30/EU (EMC) ; 2014/35/EU (LVD); UK SI 2016 No. 1101; UK SI 2016 No. 1091; UK SI 2017 No. 1206; UK SI 2012 No. 3032</p> <p>The following BSI and ETSI standards and technical specifications have been applied:</p> <p>ETSI EN 300 328 V2.2.2:2020-03; EN 62196-2:2017-06; EN IEC 61851-1:2019-10; EN IEC 61851-21-2:2021-09; EN 62196-1:2015-05; ETSI EN 301 511 V12.5.1:2017-10 ETSI EN 300 330 V2.1.1:2017-08; ETSI EN 301 489-1 V2.2.3:2020-07; ETSI EN 301 489-17 V3.2.4:2021-05</p>

* Option

Safety instructions

The Enelion charger (hereinafter referred to as the device, charger, or charging terminal) is a charging station designed for electric vehicle charging within the meaning of the 'Act on Electromobility and Alternative Fuels' dated January 11, 2018, in paragraphs 5, 12, 13, and 27 of Article 2 of the aforementioned act.

The installation and servicing of the device must be carried out by qualified and authorized individuals, and repairs may only be performed by the manufacturer or entities authorized by the manufacturer. During the warranty period, only authorized service centers and the manufacturer are allowed to perform warranty repairs.

Interference with mechanical, electrical, and electronic components, as well as the device's software, is strictly prohibited and may void the warranty. Exceptions are actions described in the following instruction manual or those agreed upon in writing with the manufacturer.

The manufacturer is not responsible for property damage resulting from prohibited interference with the product.

The electrical installation to be used during device operation must meet the conditions described in the installation manual. The manufacturer is not responsible for incorrect execution and/or protection of the electrical installation to which the device is connected.

The manufacturer is not responsible for the improper functioning of the electrical installation

to which the device is connected.

The electrical installation to be used during device operation must comply with the legal standards applicable at the installation and operation location of the device.

The manufacturer is not responsible for damages caused by an electrical installation that does not comply with legal standards.

The device does not have a built-in power switch.

The device is activated when the power supply voltage is applied. Power disconnection must be ensured by appropriate devices in the electrical installation described in the installation manual. Except in emergency situations, the device should not be switched off during the charging process.

It is prohibited to power on the device when the device housing is open.

It is prohibited to use a charger that is mechanically damaged or indicates a critical error.

Objects not intended for this purpose must not be placed in the charger socket. The only object intended for insertion into the charger socket is a functional power cable with the appropriate power and type for the electric vehicle, terminated with a functional type 2 plug according to EC 621962.

The use of extension cords, adapters, and charging cable extensions is prohibited.

The manufacturer is not responsible for loss of health or life resulting from non-compliance with the above recommendations.

During the warranty period, the manufacturer allows the purchase of support packages for the device (extended warranty/service) subject to a qualifying review before purchasing the package. Details can be obtained from the Enelion sales department.

The charging station does not support ventilation functions.

The nameplate present on the device is an integral part of it and must not be removed or damaged, as this may result in the loss of the manufacturer's warranty.



Three self-adhesive labels with information about the current value have been included in the set. Please select the appropriate one according to the specifications and affix it next to the nameplate.



input/output: 32 A, 3x400 V, 50/60 Hz

Do not access charger under power!
Warranty void if this sticker removed!



Designed & Assembled in Poland

Before the installation

- This product may only be installed, repaired or serviced by an authorized electrician. All local, regional and national electrical installation regulations must be observed. It is recommended to consider future charging needs before installation.
- The power supply to the Enelion charging terminal must be provided from an electrical switchgear. The switchgear must have the required protection in the form of a type B or C over current circuit breaker and a current rating of 32 A or less, suitable for the configuration of the device. To declare compliance with EN IEC 61851-1:2019-10, each charging point must also be individually protected against Type A and Type B residual current. This requirement must be fulfilled by one of the following:
 1. Installation of a type B residual current device (RCD B 30 mA/40 A) or RCD EV (30 mA/40 A) in the switchgear,
 2. Installation of a residual current device type A (RCD A 30 mA/40 A) in the switchgear using the Enelion RCMB – Residual Current Monitor type B provided on the charging terminal.
- The final selection of the protective equipment must be made by an authorized designer or qualified electrician.
- For maximum charging power, it is recommended to use cables with a conductor cross-section not exceeding 6 mm². This is also the maximum diameter that can be installed in the connection terminals. For convenient installation, flexible power cords

of the wire type terminated with collets are recommended.

- A residual current monitor (RCM) can be integrated into the Enelion LUMINA charger. This will switch off the current to the electric vehicle if: a residual current of 4–6 mA DC occurs. The RCM is reset by disconnecting the charging cable and reconnecting it.

Load	Charging power	
Charging current (A)	1 phase (kW)	3 phase (kW)
6	1.4	4.1
8	1.6	5.5
10	2.3	6.9
13	3.0	9
16	3.7	11
20	4.6	13.8
25	5.8	17.3
32	7.4	22

The table above shows what charging power you can expect from your installation.

The table is for information purposes only.

How to prepare the device for installation

ENELION LUMINA SOCKET



- 01** Undo two long bolts and two screws at the bottom (1). Repeat with two screws at the top (2)

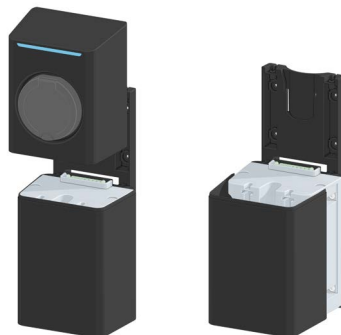

- 02** Slide out the head module and remove the housing cover

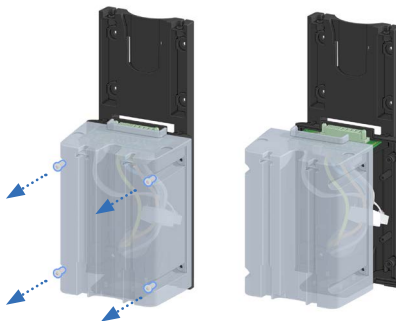

- 03** Unscrew the fixing screws and remove the transparent cover

ENELION LUMINA ALU SOCKET



01 Undo two long bolts at the bottom (1) and two screws at the top (2)



02 Slide out the head module

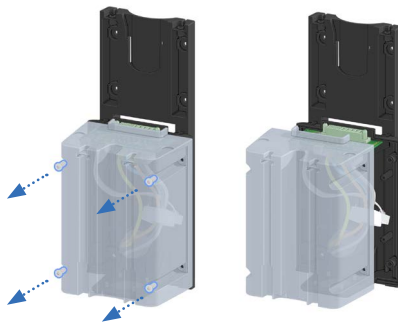

03 Unscrew the fixing screws and remove the transparent cover

ENELION LUMINA ALU CABLE



- 01 Dismantle the cable holder (1). Undo two long bolts at the bottom (2) and two screws (3) at the top



- 02 Slide out the head module

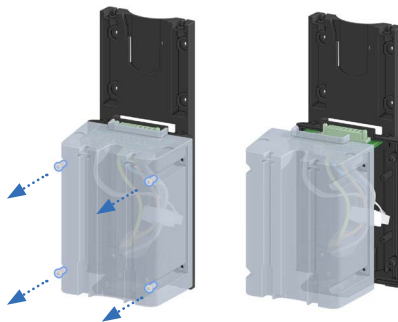

- 03 Unscrew the fixing screws and remove the transparent cover

Installation

Do not carry out outdoor installation during rain or strong winds if there is a risk that water or debris may enter the device.

All of the operations described in this manual should be carried out after making sure that there is no voltage in the power cord.

This product may only be installed, repaired or serviced by an authorized electrician. All local, regional and national electrical installation regulations must be observed.



Video tutorial

<https://enlion.com/support-lumina/>

In addition to the steps described on the following pages, we recommend watching the installation videos.

01

Diagrams of connection variants

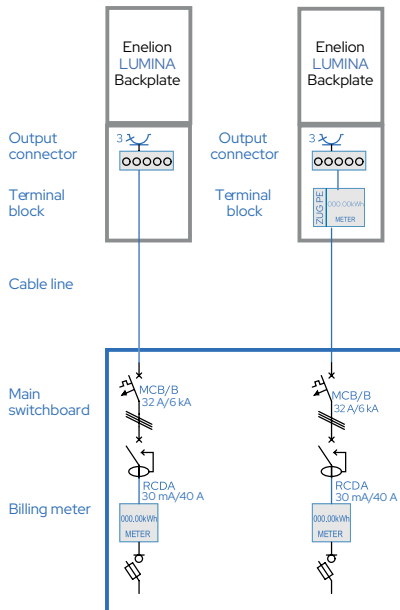

02

Overview diagrams of modules

Charging module
Type 2 socket
with RCMB 6 mA DC

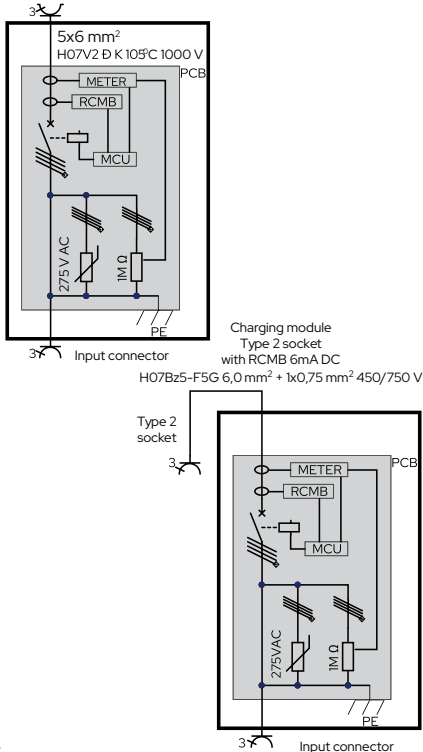

03

Preparation

In the box with the Enelion LUMINA charger, you will find an assembly template to help you choose the installation location and prepare the installation holes.

We recommend that you position the station so that the top edge of the charging station is approximately 130 cm from the floor.

The electrical cable can be connected to the station from above, from below and directly from behind the station at the gland marked on the template.

The design of the station allows both wall and pole installation (additional installation components required – sold separately). We suggest that there is local Wi-Fi network coverage at the station installation site and/or LTE mobile network coverage if the station is to be used online.

03.1 Power Supply Network Systems

Enelion charging stations are designed for five-wire power supply. In a TN-S 230/400V network, this is the standard option.

TN-S 230/400 V

Generator or transformer

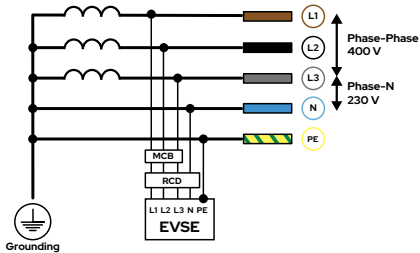

It is possible to power the station from other network systems described below:

TT 230/400 V

Generator or transformer

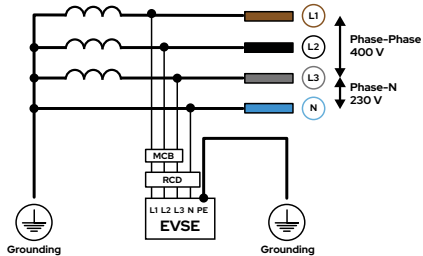

In the TN-C system configuration, you should separate the PEN conductor into N and PE as shown in the diagram below.

TN-C

Generator or transformer

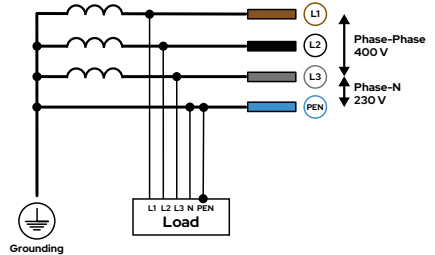

TN-C

Generator or transformer

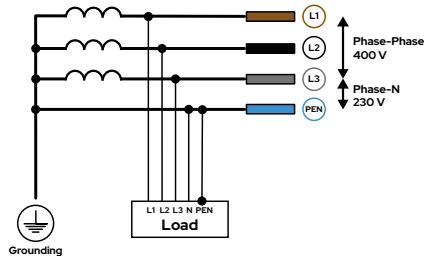

In the case of an IT network with 120/230 V, as found in Norway, the connection appears as follows.

It should be noted that one of the phases serves as the Neutral conductor, which is important during the installation of RCD (Residual Current Device). In such a network, it is not possible to charge in three phases; only some vehicles will be able to charge in two phases.

Other, more complex power systems require technical consultation before purchase.

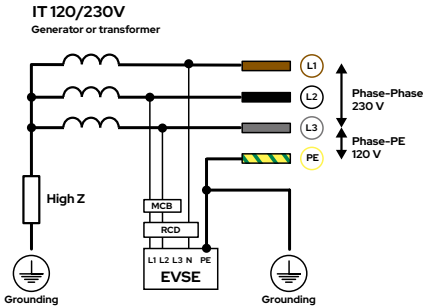

It is not possible to power the station from an IT network with 230/400V.

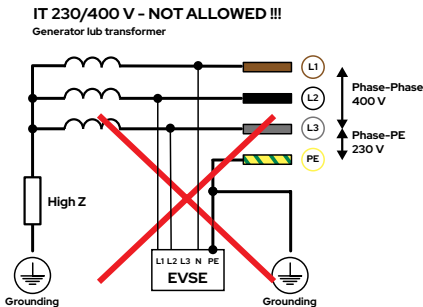

04 Installation of mounting plate



Turn off the power before installation.

1. Connect the electrical cable.
2. Hang the mounting plate according to the template.
3. Secure electric cable in the gland.

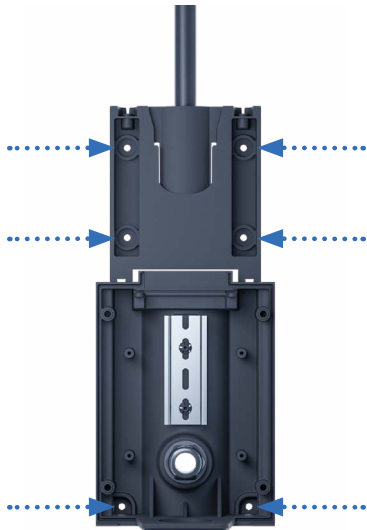

05 Electrical connection

For maximum charging power, it is recommended to use cables with a conductor cross-section not exceeding 6 mm². This is also the maximum diameter that can be installed in the connection terminals. For convenient installation, flexible power cords of the wire type terminated with collets are recommended.

Installation of the cables in the station cable terminals does not require any special tools.

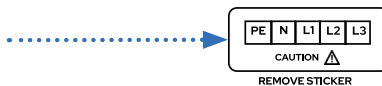

The label placed on the connectors indicates the sequence of connecting phase wires. To connect the wires, remove the label.

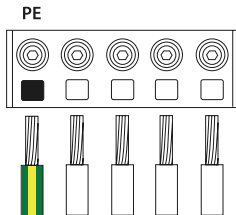

TN 3-phase (230 V)

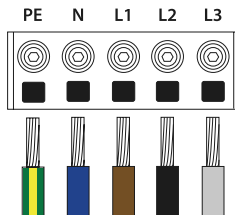

TN 1-phase (230 V)

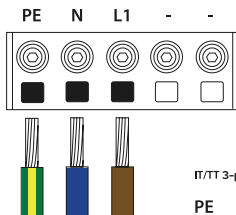

IT/TT 3-phase (230 V)

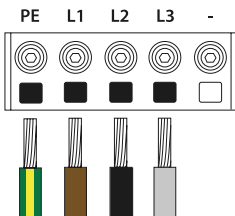

IT/TT 1-phase (230 V)

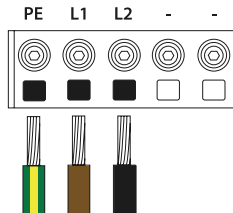

It is recommended to use the existing colour code used in the wiring. Depending on the standard in your country, the cable colours may differ from those shown.



Before switching on the power, make sure that the cables are connected correctly. Test this by pulling on each wire.

After preparing the installation, close the transparent cover.

06 Alternative method for the insertion of power cables

If it is not feasible to insert the power cables in the standard way, an alternative method can be applied.

In the lower part of the rear housing of the station (if it is not equipped with the optional 230 V socket), there is a hole for an M25 cable gland with a blanking plug.



If necessary, the installer can remove the blanking plug and insert the removed cable gland from the standard installation variant in its place.



In order to maintain the warranty, the previously removed plug must be installed in place of the originally installed cable gland.



Blanking plug in place of originally installed cable gland

07

M20 gland adapter

For the alternative method of inserting power cables into the station, an adapter with a hole for M20 gland is available separately – it can be used to install a special gland with an armoured cable in case of a single-phase system.

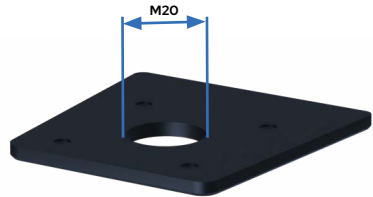

Hole for M20 gland

08 Measuring a 230 V socket.

There are two options when it comes to measuring a 230 V socket.

1. Use a single-phase MID meter. To do this, you should connect the socket to the meter according to the diagram shown in the drawing.

The charger's power supply is connected directly to the board presented in **chapter 5**.

Measuring energy consumption solely through a 230 V socket.

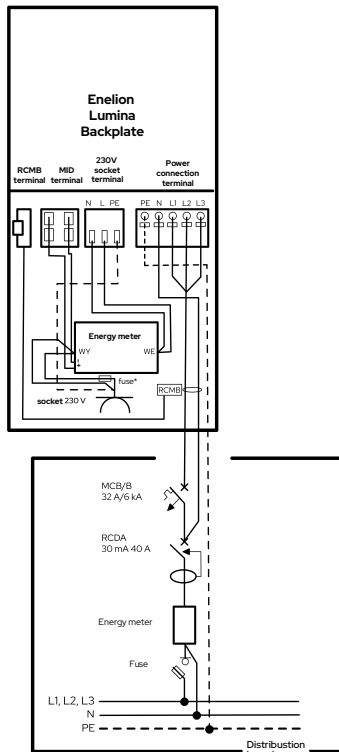

*0234010.MXP (Cartridge Fuse 250V 10a Medium Acting)

Electrical connection of ENELION LUMINA in the case of measuring a 230 V socket.

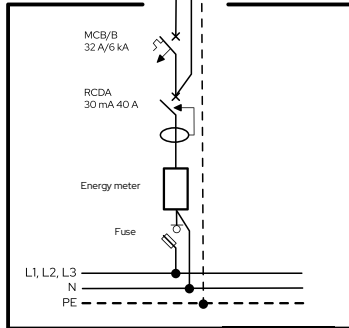
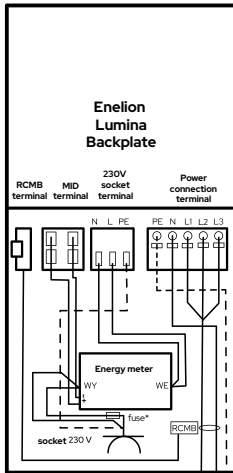

Power connection in the case of measuring the entire ENELION LUMINA charger.

- Measuring the Type 2 car charging socket and the 230V socket.

In this case, you should connect it according to the diagram next to it.



We do not recommend using a 230 V socket for charging your car because it may overload the connection.

More information related to measuring the 230 V socket can be found in the user manual.

09 Ethernet connection.

The Ethernet module is installed in ENELION LUMINA chargers on the back of the device on the left side. The Ethernet cable can be routed through a special opening in the back cover and is secured against being pulled out by a special clamp installed in the charger.



The opening in the back cover of ENELION LUMINA is designed for cables with a maximum outer diameter of 6 mm.



After installing the Ethernet cable, you should activate the Ethernet module in the configuration panel following the instructions provided in the user manual.

10 Wired communication in ENELION LUMINA.

Wired communication in ENELION LUMINA is based on a serial, wired CAN bus. For installation, it is recommended to use a CAT5e or better Ethernet cable with copper conductors, not CCA - Copper Clad Aluminium.

Communication utilizes a single twisted pair of wires and the shield of the cable. The total length of the cable must not exceed 500 meters. The socket for connecting the CAN communication cable is shown in figure:

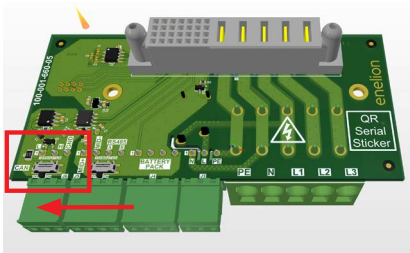

Due to differences in the implementation of CAN communication in ENELION LUMINA chargers and Enelion Wallbox, Vertica, and Stilo chargers, it is not possible to connect them in a single chain.

To terminate, use the switch shown in the diagrams in devices located at the beginning and end of the charger chain.

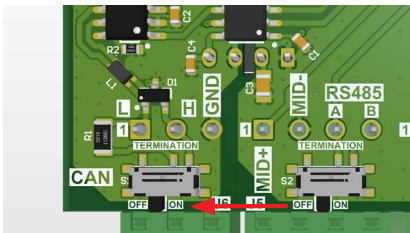
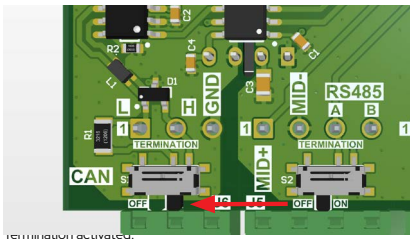

Termination deactivated.

11 Step by step

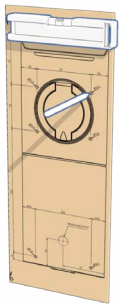

01 Level the template
- mark the holes

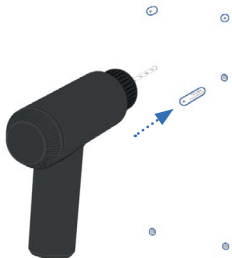

02 Drill holes
- insert pins

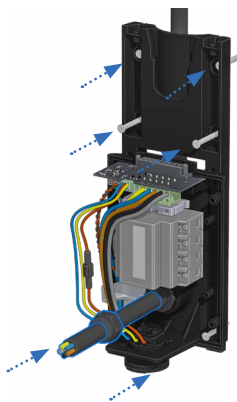

03 Screw the backplate to walls - tighten the cable entry

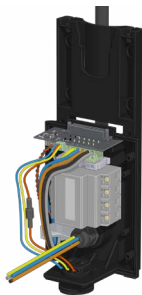

04 Remove the insulation
from the cable



05 Connect wires

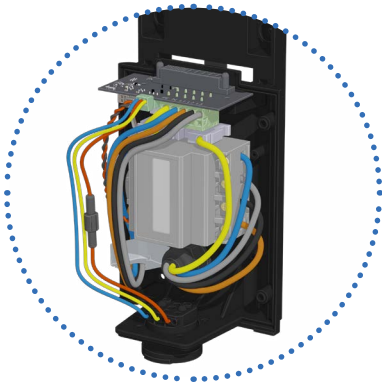

05a

MODEL LB-32-3-X-1-X-XX-MGR-00

Enelion LUMINA
with optional
230 V CEE 7/3 SOCKET
and optional CERTIFIED
ENERGY METER

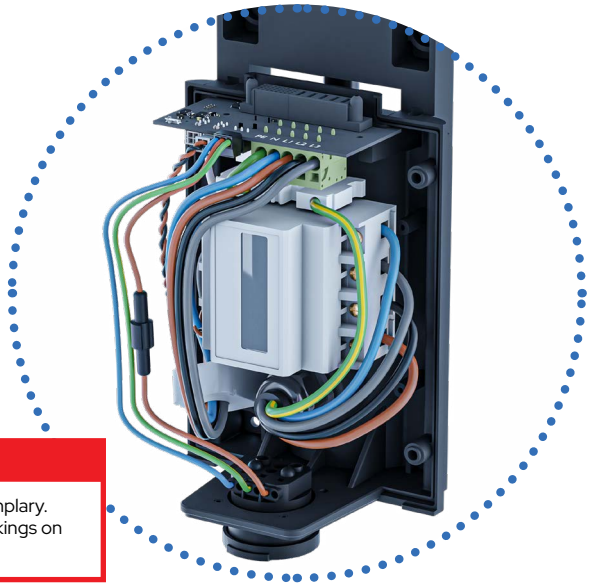

The presented connection is exemplary.
Before installation, check the markings on
the mounted meter.

05b

Enelion LUMINA
with optional 230 V
CEE 7/3 SOCKET

MODEL LB-32-3-X-1-X-XX-GR-00

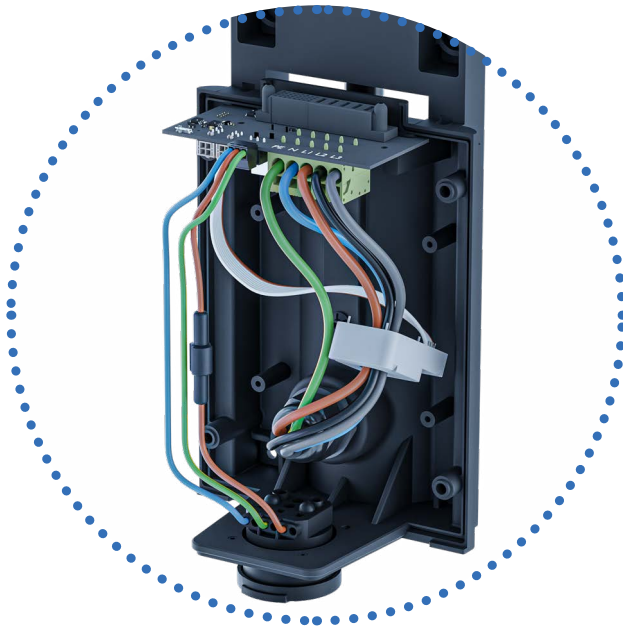

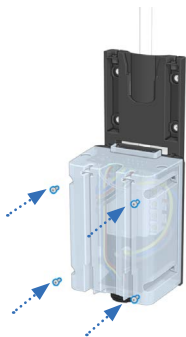

06 Install the transparent cover using four screws.

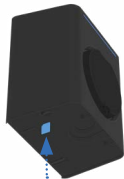

07 Insert SIM card

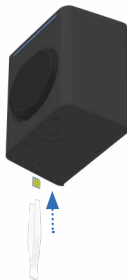

Slide



08a Mount the head on

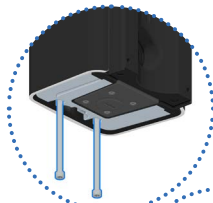

08b Tighten the head – two long bolts at the bottom and two screws at the top



ENELION LUMINA SOCKET



Slide from the front

09a Install front cover

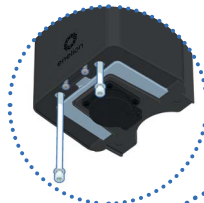

09b Use two long bolts and two screws at the bottom and two screws at the top

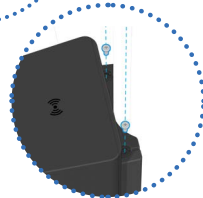

08 Start-up and configuration of the station

Switching on the safety devices, which turns on the voltage at the station, should be carried out by a suitably qualified person.

Using a smartphone or computer, search for the LUMINA station's AP with the SSID listed on the back of the charging head.

After connecting to the LUMINA station's AP with the SSID and password given on the back of the charging head, type the following into the address bar of your browser: <http://192.168.8.8>

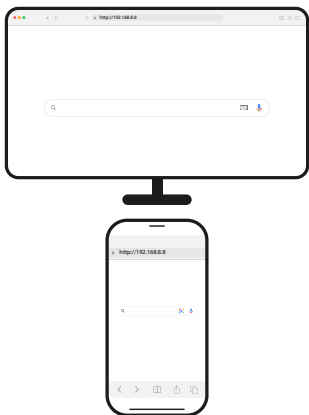

Access to the configuration panel is protected by a password, which by default is **admin**.

It is also possible to log into the simplified version of the panel via your **user** account and password **user**.

The password should be changed if necessary.



The configuration process should be carried out according to the instructions on the panel.

Additional information for the UK market

This section outlines the information for installation of Enelion LUMINA in the UK region.

Part Numbers Affected: Heads:

LH-32-1-X-0-S-04-EO-00; LH-32-1-S-0-S-04-EO-00; LH-32-1-B-0-S-04-EO-00; LH-32-1-S-0-C-50-EO-00; LH-32-1-B-0-C-50-EO-00



The label placed on the connectors indicates the sequence of connecting phase wires. To connect the wires, remove the label.



Connection for Pen Fault Detection configured charger Head. **Pay attention to different connection of PE conductor!**

01 Pen Fault Detection

To follow and be compliant with the regulations specified by IET in clause 722.411.4.1 (iv), Enelion LUMINA uses a technology that enables you to directly connect your charger to a PME supply.

Enelion LUMINA now includes a safety monitoring system to detect potential earth-neutral faults. If faults are detected in the circuit, the charge cycle ends thus isolating the vehicle from the power supply.

This removes the risk of touching the vehicle and a potential shock if earth-neutral fault is present.

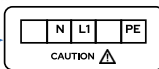
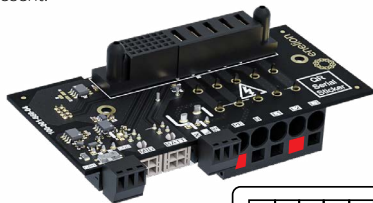

STANDARD	PE	N	L1	L2	L3
UK	-	N	L1	-	PE

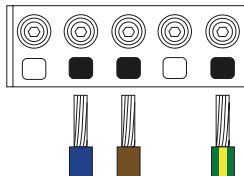

Daily use and operation

01

How do I charge?

Before using the Enelion LUMINA charger, ensure that the following requirements are met:

- An authorized electrician has made the electrical connection correctly.
- The charger is correctly configured.
- The software is up to date.
- If access control is configured, block it with a registered RFID tag or disable it in the configuration panel on the Wi-Fi interface.

Before each use of the Enelion LUMINA charger:

1. Check that the charging cable and connector are not damaged or contaminated, e.g. due to foreign objects or water.
2. Connect the charging cable to the Enelion LUMINA charger and to the electric car. The charging process starts and adapts automatically to the electric car and the available power based on its configuration. If the car does not start charging, check that charging is enabled in your car and that the connectors are correctly connected.

02 Interface LED

The Enelion LUMINA charging station has an LED interface that provides the user with basic information:

Status	Light type
Availability	Green flashing
Charging (energy transfer in progress)	Blue flashing from inside towards the edge
Charging (no energy transfer)	Blue flashing
Warning/minor error (the charger will attempt to return to its previous state)	Yellow flashing
Error	Red flashing
Fatal error	Steady red
Authorization	Light type
User acceptance	Running from left to right in green
User rejection	Running from left to right in red
Authorization pending	White dot moving from left to right

The interface provides only basic operational information, detailed information can be read from the configuration panel.

03 Maintenance

The manufacturer recommends conducting an inspection of the device once every 12 months for safety and maintenance reasons. The inspection is not mandatory.

The device is designed to operate in temperatures from -30°C to $+55^{\circ}\text{C}$. The manufacturer does not guarantee the correct operation of the charging station at temperatures outside of the specified range. Chargers damaged by temperatures below -30°C or above $+55^{\circ}\text{C}$ are not covered under the warranty.

04 Cleaning

The correct way to clean the charger is to wipe the casing with a microfibre cloth using a cleaner dedicated to the plastic of the casing. Plastic parts (the socket) should be cleaned with a microfibre cloth using a cleaning agent dedicated to glass. Other cleaning methods (e.g. using a wire brush) may damage the casing.

Damage caused by improper cleaning of the device does not constitute grounds for warranty claims.

Practical details

Standards

Enelion sp. z o.o. hereby declares that this product, the Enelion LUMINA charging station, complies with:

2014/53/EU (RED); 2011/65/EU (RoHS), 2014/30/EU (EMC) ; 2014/35/EU (LVD); UK SI 2016 No. 1101; UK SI 2016 No. 1091; UK SI 2017 No. 1206; UK SI 2012 No. 3032

The following BSI and ETSI standards and technical specifications have been applied:

ETSI EN 300 328 V2.2.2:2020-03; EN 62196-2:2017-06; EN IEC 61851-1:2019-10; EN IEC 61851-21-2:2021-09; EN 62196-1:2015-05; ETSI EN 301 511 V12.5.1:2017-10 ETSI EN 300 330 V2.1.1:2017-08; ETSI EN 301 489-1 V2.2.3:2020-07; ETSI EN 301 489-17 V3.2.4:2021-05

The full content of the declaration of conformity is available at: enelion.com

Disposal

This electronic equipment must not be disposed of with household waste. There may be free collection points available in your area where you can hand over your old equipment. Please follow local regulations for proper and environmentally friendly disposal. If your old electronic equipment contains personal data, you are responsible for removing this data before returning the equipment.

Repair

The manufacturer allows for the repair of public, publicly accessible charging stations without the need for UDT reapprovals (if the charger's parameters have not changed).

The manufacturer permits modular repair, i.e., replacing the entire module or device instead of repairing individual components.

If your charger requires repair, please contact your distributor.

Returns and complaints

For product returns and complaints, please contact your distributor or Enelion customer service.

Customer service

Download the latest user manuals, useful documents and videos for your product on <https://enelion.com/support-lumina/>

This document contains information that is subject to change without notice.

© 2024 ENELION

52 Miałki Szlak St , 80-717 Gdansk, Poland

Copyright Enelion sp. z o.o.

The manual may change as the product develops.
All rights reserved.

Revision: V 7.2

Number of pages: 40

Released: February 10, 2024



Enelion sp. z o.o. | 52 Miałki Szlak St
80-717 | Gdansk | Poland

sales@enelion.com

enelion.com

